

# TOBEE

**Always do your best pump®**



## Series TP, TPR Vertical Sump Pumps



# Design & Applications

## Overview

Tobee® TP/TPR vertical sump pump is designed for applications requiring greater reliability and durability than conventional vertical process pumps can offer. Fully elastomer lined or hard metal fitted. No submerged bearings or packing. High capacity double suction design. Optional recessed impeller and suction agitator available.

## Design Features

**Bearing Assembly** - The bearings, shaft and housing are generously proportioned to avoid problems associated with the operation of cantilevered shafts in the first critical speed zones.

The assembly is grease lubricated and sealed by labyrinths; the upper is grease purged and the lower protected by a special flinger. The upper or drive end bearing is a parallel roller type whilst the lower bearing is a double taper roller with preset end float. This high performance bearing arrangement and robust shaft eliminates the need for a lower submerged bearing.

**Column Assembly** - Completely fabricated from mild steel. The TPR model is elastomer covered.

**Casing** - Has a simple bolt-on attachment to the base of the column. It is manufactured from a wear resistant alloy for the TP and from moulded elastomer for the TPR.

**Impeller** - Double suction impellers (top and bottom entry) induce low axial bearing loads and have heavy deep vanes for maximum wear resistance and for handling large solids. Wear resistant alloys, polyurethane and moulded elastomer impellers are interchangeable. The impeller is adjusted axially within the casting during assembly by external shims under the bearing housing feet. No further adjustment is necessary.

**Upper Strainer** - Drop-in metal mesh; snap-on elastomer or polyurethane for TP and TPR pumps. Strainers fit in column openings.

**Lower Strainer** - Bolted metal or polyurethane for TP; moulded snap-on elastomer for TPR.

**Discharge Pipe** - Metal for TP; elastomer covered for TPR. All wetted metal parts are completely rust protected.

**Submerged Bearings** - None

**Agitation** - An external agitator spray connection arrangement can be fitted to the pump as an option. Alternatively, a mechanical agitator is fitted to an extended shaft protruding from the impeller eye.

**Materials** - Pumps can be manufactured in abrasive and corrosive resistant materials.



## Applications

The rugged Tobee® TP/TPR Heavy Duty Sump Pumps are available in a wide range of popular sizes to suit most pumping applications. Thousands of these pumps are proving their reliability and efficiency worldwide in:

- Minerals processing
- Coal preparation
- Chemical processing
- Effluent handling
- Sand and gravel

and almost every other tank, pit or hole-in-the ground slurry handling situation.

The Tobee® TP/TPR design with either hard metal (TP) or elastomer covered (TPR) components makes it ideal for:

- Abrasive and/or corrosive slurries
- Large particle sizes
- High density slurries
- Continuous or stop operation
- Heavy duties demanding cantilever shafts

# Options - Metal or Rubber

## Sectional Arrangement

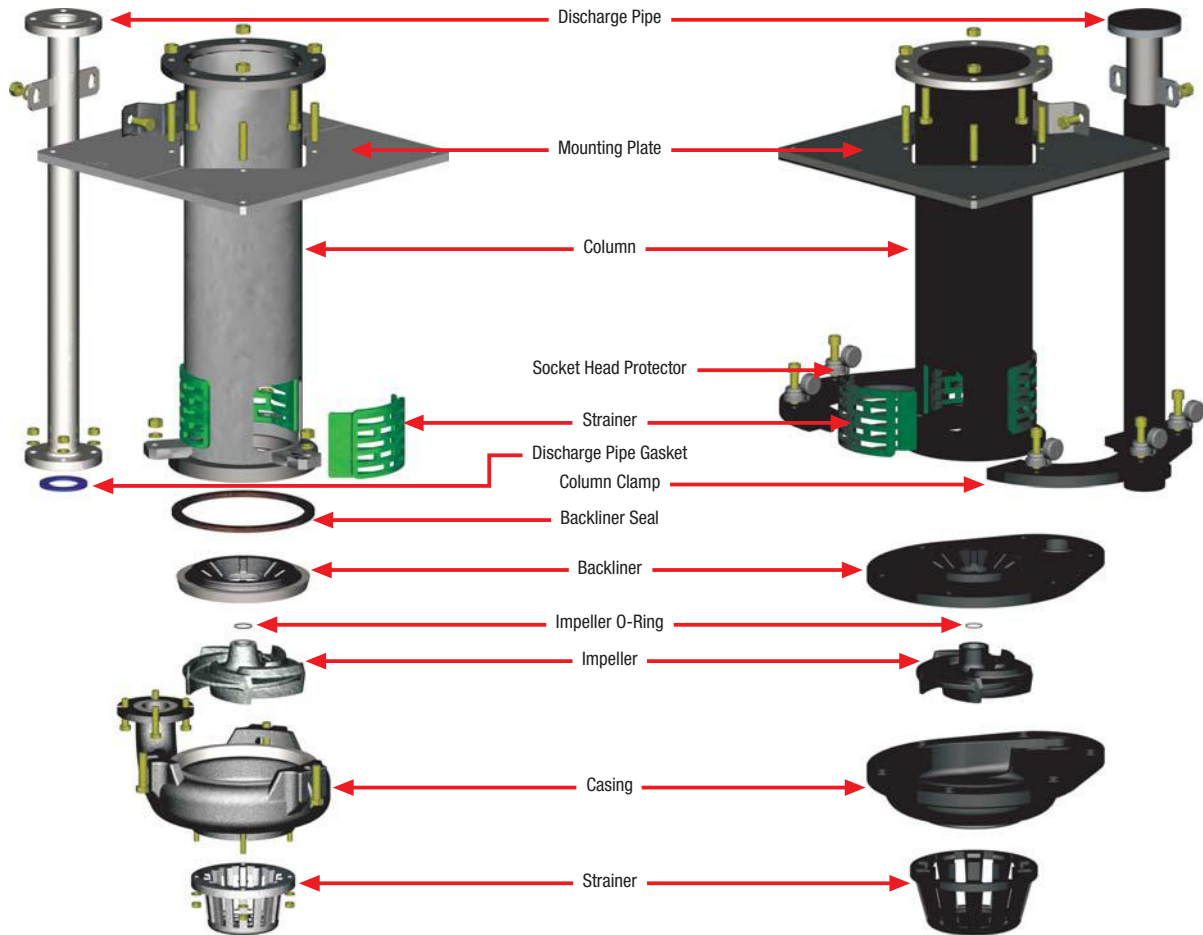

### Tobee Metal Sump Pump - TP

(TP65QV Shown)

### Tobee Elastomer Sump Pump - TPR

(TPR65QV Shown)

Tobee TP/TPR Heavy Duty Sump Pumps are available in various standard lengths to suit common sump depths, for very deep sumps or where high shaft speeds limit the length of the pump, a suction extension pipe can be fitted to the bottom inlet to extend the depth of the pump by up to 2 metres.

Pumping is maintained even when the top inlet is not submerged, thus enabling the level of liquid to be lowered right down to the bottom inlet or the bottom of any suction extension pipe.

To suit special requirements other Tobee pump wet ends can be fitted to the standard Tobee TP pump dry end.

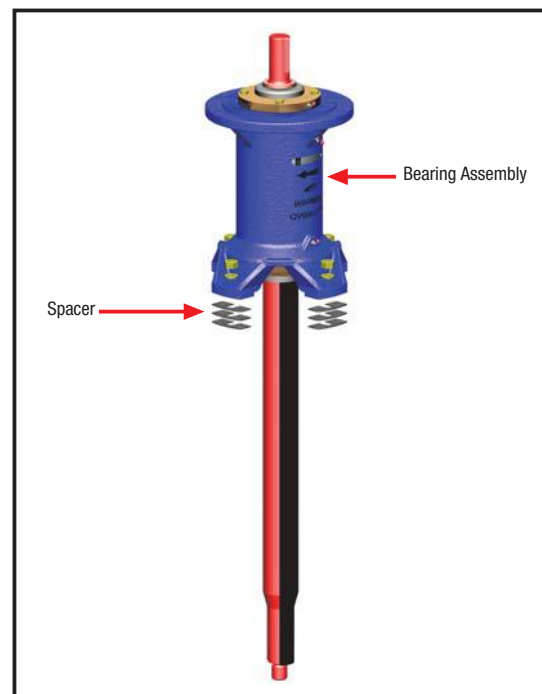
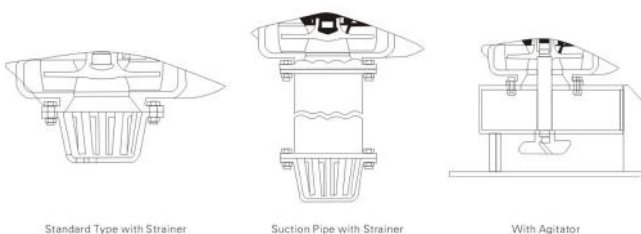

# Selection Chart

## Quick Selection Chart

### Tobee Vertical Sump Pumps - Quick Selection Chart

Approximate clear water performance - to be used as a first guide only

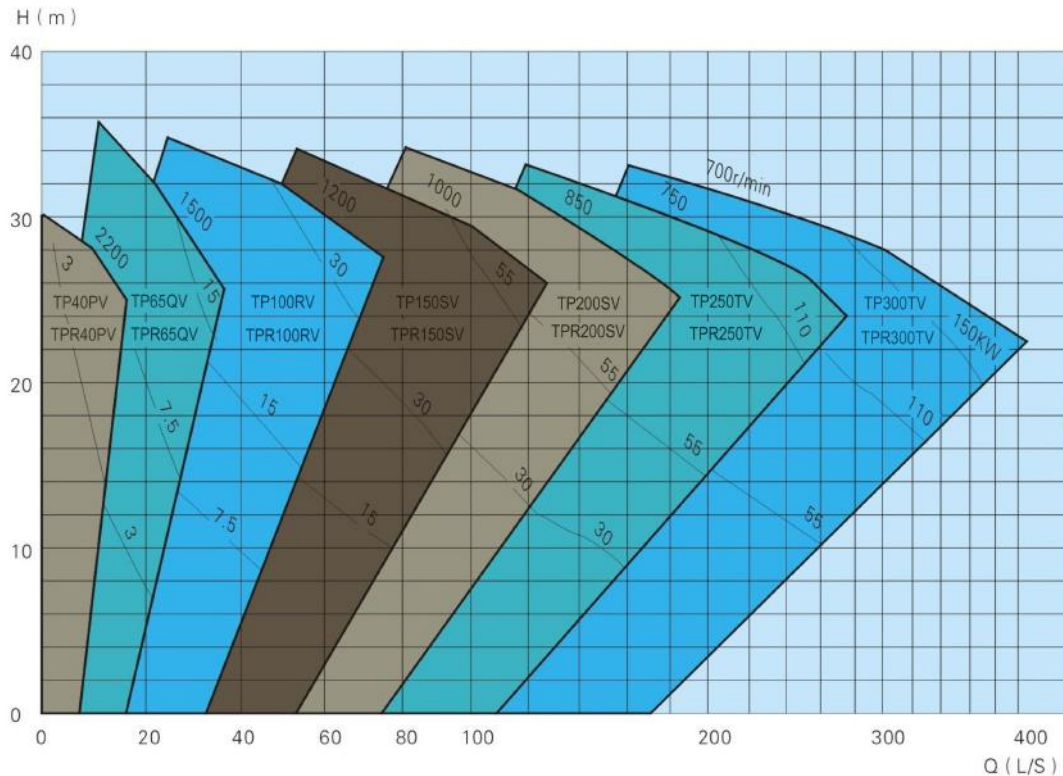

## Performance Parameters

MODEL	MAX. POWER P	CAPACITY Q	HEAD H	SPEED N	EFFICIENCY	NPSH	IMPELLER DIA.
	(kw)	(m3/h)	(m)	(rpm)	(%)	(m)	(mm)
TP40PV	15	19.44-43.2	4.5-28.5	1000-2200	40	-	188
TPR40PV	15	17.28-39.6	4-26	1000-2200	40	-	188
TP65QV	30	23.4-111	5-29.5	700-1500	50	-	280
TPR65QV	30	22.5-105	5.5-30.5	700-1500	51	-	280
TP100RV	75	54-289	5-35	500-1200	56	-	370
TPR100RV	75	64.8-285	7.5-36	600-1200	62	-	370
TP150SV	110	108-479.16	8.5-40	500-1000	52	-	450
TPR150SV	110	108-479.16	8.5-40	500-1000	52	-	450
TP200SV	110	189-891	6.5-37	400-850	64	-	520
TPR200SV	110	189-891	6.5-37	400-850	64	-	520
TP250TV	200	261-1089	7.5-33.5	400-750	60	-	575
TPR250TV	200	261-1089	7.5-33.5	400-750	60	-	575
TP300TV	200	288-1267	6.5-33	350-700	50	-	610
TPR300TV	200	288-1267	6.5-33	350-700	50	-	610

# Dimensions

## Installation Drawing

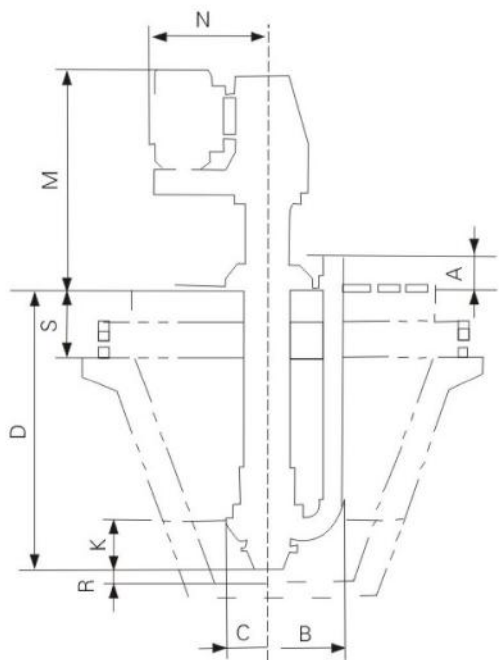

Belt Drive

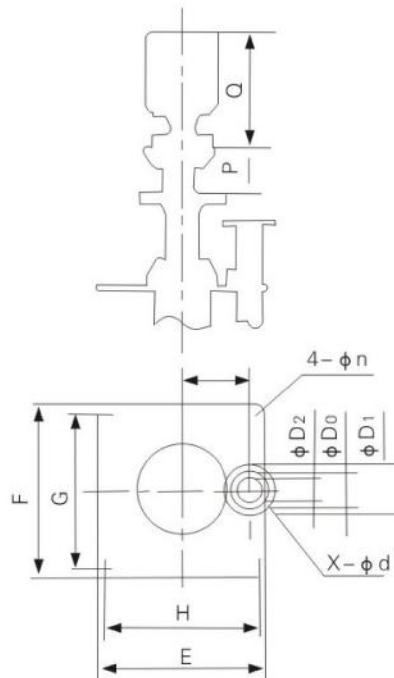

Direct Drive

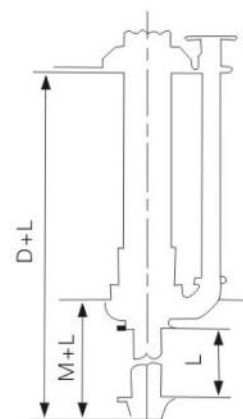

PUMP			A	B	C	D		E	F	G	H	J	φn	K	M	N	P	Q	PUMP WEIGHT (kg)	S	DISCHARGE FLANGE SIZE			
SIZE (mm)	FRAME	TYPE				STANDARD TYPE	EXTERNAL TYPE														φD1	φD2	φD0	X-φd
40	PV(L)	TP	137	285	153	900*	1800*	500	500	450	450	205	18	174	1113	675	248	629	285	280	127	40	98	4-φ16
		TPR	140	265	175	1200	2500								1113									
65	QV(L)	TP	227	399	231	900	2200*	680	680	620	620	285	18	265	1390	794	290	681	432	350	178	65	140	4-φ19
		TPR	230	380	260	1200*	2500								1396									
100	RV(L)	TP	265	538	317	1200	2400	1000	870	800	930	400	22	393	1803	1020	416	960	867	350	229	100	191	8-φ19
		TPR	266	535	332	1500*	2700*								1809									
150	SV(L)	TP	390	670	365	1500	2800*	1100	1100	1030	1030	500	28	475	2186	1200	476	1011	1737	350	280	150	241	8-φ22
		TPR	395	670	400	1800*	3200								2194									
200	SV(L)	TP	450	805	440	1500	2800*	1300	1200	1100	1200	600	28	550	2191	1300	476	1011	2800	350	343	200	298	8-φ22
		TPR				1800*	3200								2191									
250	TV(L)	TP	500	930	470	1800	2800*	1750	1450	1350	1650	700	48	685	2572	1750	561	1246	3700	400	406	250	362	12-φ25
		TPR				2100*	3200								2572									
300	TV(L)	TP	500	1170	559	1800	2800*	1750	1450	1350	1650	700	48	700	2476	1750	561	1246		400	483	300	432	12-φ25
		TPR	400	1090	630	2100*	3200								2832									

NOTE: L size:0, 300, 600, 900, 1200, 1800, Standard pump:L=0.  
R dimension range:300-500mm.

# Materials - Metal

## Material Options - Metal

### Tobee Material Options - Metal

Material Types and Data Descriptions - to be used as a first guide only

Material Code	Material Name	Mechanical Property			Application
		$\delta_w/\delta_b$ (Mpa)	ak (J/cm <sup>2</sup> )	HRC	
T05	KmTBCr27	≥700	6-10	62	Alloy T05 is a wear resistant white iron that offers excellent performance under erosive conditions. The alloy can be effectively used in a wide range of slurry types, Alloy T05 is particularly suited to applications with PH 5~12
T07	KmTBCr15Mo	≥550	4-8	65	Alloy T07 is a martensitic wear resistant alloy, It has higher impact resistance than Alloy T05. Alloy T07 is also suited to applications with PH 5~12
T01	KmTBCr8	≥550	6-8	55	Alloy T01 erosion resistance is 0.9 time than T05, It is suited to mud and mortar.
T11	KmTBMnMo	≥400	3-6	38-42	Alloy T11 has lighter erosion resistance, it can be drilled and tapped, and suitable for light wear application with fine particles.
T49	Cr30	≥600	5-7	43	Alloy T49 is a corrosion resistant white iron suitable for low PH corrosion duties, The alloy is particularly suitable for Flue Gas Desulphurization (FGD) and other corrosive applications, where the pH is less than 4.
T33			5-7	35	Alloy T49 is a corrosion resistant white iron has certain erosion resistance, It is suitable for oxidative slurry with PH ≥1, Especially for sphogypsum and nitric acid, sulfuric acid and phosphoric acid etc
T22		1200		45	Alloy T22 is a wear resistant cast steel that offers excellent erosion resistance and high hardness, It is suitable for dredging application.
T23	Cast Steel	700		HB 500-600	Alloy T23 is a anti-wear cast steel with preferable hardness and abrasion resistance, It is suitable for high wear condition.
T25	NiCrMo Steel			HB 300-350	Alloy A25 is an cast steel having moderate wear resistance and high mechanical properties. The alloy is used for large castings where toughness is of primary importance.
T12	Hyperchrome		2-5	67	Alloy T12 is a hypereutectic white iron suitable for high wear duties, It can be used in mild alkaline slurries with PH 6~14. The T12 alloy may provide up to 3 times the wear life of T05 parts in some severe applications.
T61	Hyperchrome		5-6	67	Alloy T61 has better toughness than Alloy T12. It can be more higher hardness by heat treatment, Mainly used for high abrasive slurry with fine particles with PH 6-14.
T-CD4	CD4MCuN	690	≥100	27	Alloy T-CD4 is a duplex stainless steel that offers superb corrosive resistance, It is particularly suitable for transporting limestone and gypsum slurry with PH 2.5-13, Chloride concentration: ≤60000ppm.
T2205	Duplex SS	≥680	78(8)	HV260	Alloy T2205 is a duplex stainless steel suitable for lower corrosive duties, The performance is similar with T-CD4, Since It lacks the copper addition of T-CD4, it would not be expected to do as well as CD4MCuN in sulfuric acid.
T-SiC	Si3N4-SiC	620	6-7	HM8.9	Ceramic T-SiC is a wear resistant silicon nitride bonded silicon carbide, It offers 3~5 times work life than T05 standard high chrome alloy.

# Materials - Rubber

## Material Options - Rubber

### Tobee Material Options - Rubber

Material Types and Data Descriptions - to be used as a first guide only

Material Code	Material Name	Description & Application
RU08	Natural Rubber	RU08 is a black natural rubber, of low to medium hardness. RU08 is used for impellers where superior erosive resistance is required in fine particle slurries. The hardness of RU08 makes it more resistant to both chunking wear and dilation (i.e.: expansion caused by centrifugal forces) as compared to RU26. RU08 is generally only used for impellers.
RU26	Natural Rubber	RU26 is a black, soft natural rubber. It has superior erosion resistance to all other materials in fine particle slurry applications. The antioxidants and antidegradents used in RU26 have been optimized to improve storage life and reduce degradation during use. The high erosion resistance of RU26 is provided by the combination of its high resilience, high tensile strength and low Shore hardness.
RU33	Natural Rubber (Soft)	RU33 is a premium grade black natural rubber of low hardness and is used for cyclone and pump liners and impellers where its superior physical properties give increased cut resistance to hard, sharp slurries.
RU38	Natural Rubber	RU38 is a black natural rubber with medium hardness, It is used for impellers where superior erosive is required in fine particle slurries.
RU55	Anti Thermal Natural Rubber	RU55 is a premium grade material for high abrasion and corrosion application. Superior physical properties give increased cut resistance to hard, sharp particle slurries. It has also superior erosion resistance to all other materials in fine particle slurry applications.
SY02	EPDM Elastomer	SY02 is an acid resistant rubber which is of medium abrasion resistance.
SY12	Nitrile Elastomer	SY12 is a synthetic rubber which is generally used in applications involving fats, oils and waxes. It has moderate erosion resistance.
SY21	Butyl Rubber	SY21 exhibits excellent chemical stability and good resistance to heat and oxidation. It is generally used in acidic applications.
SY31	Hypalon	SY31 is an oxidation and heat resistant elastomer. It has a good balance of chemical resistance to both acids and hydrocarbons
SY42	Neoprene	SY42 is a high strength synthetic elastomer with dynamic properties only slightly inferior to natural rubber. It is less effected by temperature than natural rubber, and has excellent weathering and ozone resistance. It also exhibits excellent oil resistance.
SY51	Viton	SY51 has exceptional resistance to oils and chemicals at elevated temperatures. Limited erosion resistance.
PU38	Polyurethane	PU38 is an erosion resistant material that performs well in elastomer applications where 'tramp' is a problem. This is attributed to the high tear and tensile strength of PU38. However, its general erosion resistance is inferior to that of natural rubber (RU26, RU08).

# Tobee Products

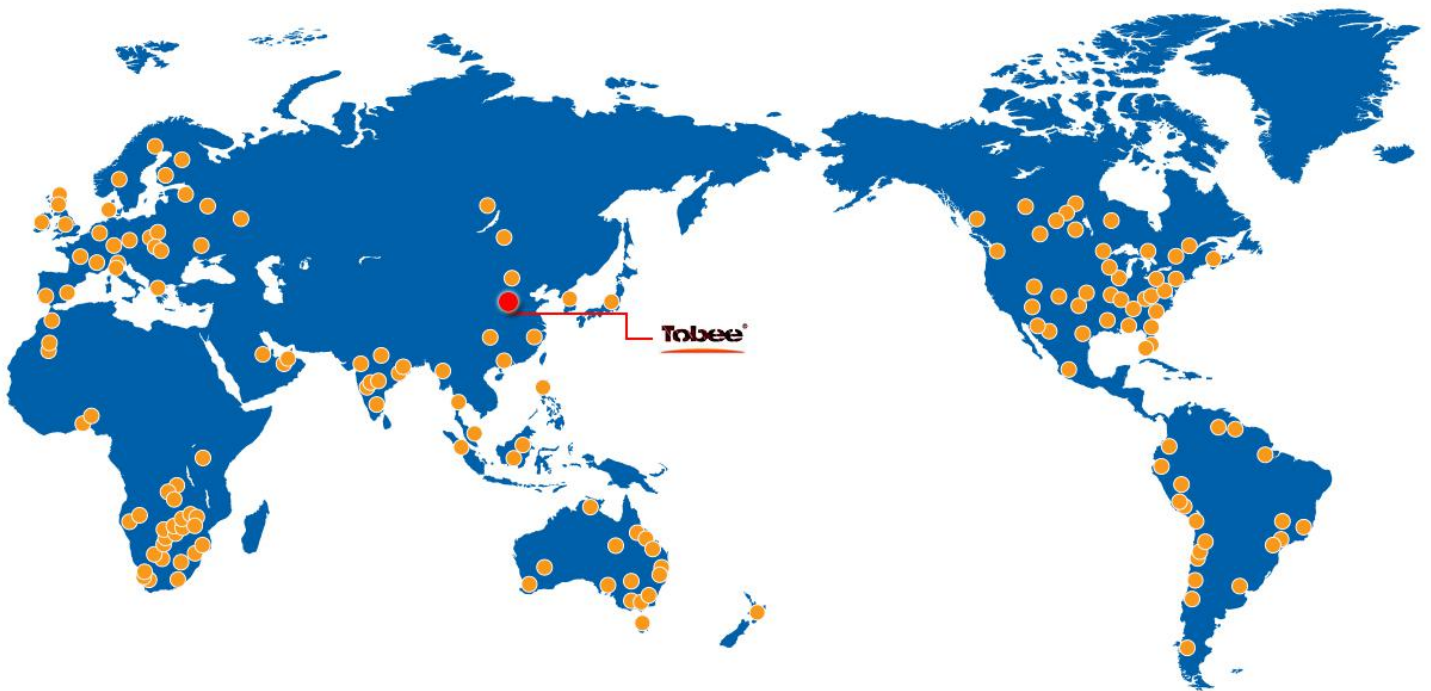

**Tobee®** Centrifugal Slurry Pumps  
**Extreme®** Heavy Duty Slurry Pumps  
**Hydroman®** Submersible Slurry Pumps  
**Aeries®** Self-priming Trash Pumps  
**Aggressor®** Chemical Pumps  
**FlowGate®** Slurry Valves

**Extrachrome®** Metal Parts  
**Synthmoer®** Rubber Parts  
**PolyFerric®** Polyurethane Parts  
**PreCast®** OEM Services  
**i-Drive®** Transmission Module Design  
**Hi-Lock®** Sealing Design

## HEBEI TOBEE PUMP CO.,LIMITED

No. 266, Tianshan St,  
High-tech Zone,  
Shijiazhuang City  
050000, China.

Tel.: +86 18032034573  
Fax.:+86-0311-87221317  
Email: Sales@tobeeump.com  
Web: www.tobeeump.com



Always do your best pump®